

# Zeichnungen zum Werkzeugsatz

## 4250 Werkzeugrolle / Værktøjsmappe

Von der Werkzeugrolle liegt mir bisher leider keine Zeichnung vor

## 4252 Schraubendreher ganzmetall / Skruetrækker

Von dem Schlitzschraubendreher liegt mir bisher leider keine Zeichnung vor

## 4253 Kombizange / Universaltang

Von der Kombizange liegt mir bisher leider keine Zeichnung vor

## 7634 Zündkerzenschlüssel / Topnøgle for Tændrør

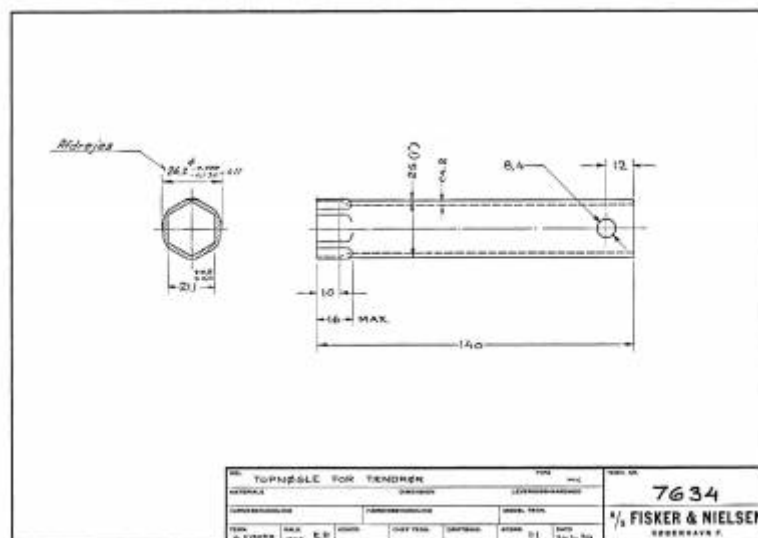

## 7635 Rohrsteckschlüssel 10 x 14 SW / Topnøgle 10 - 14 mm

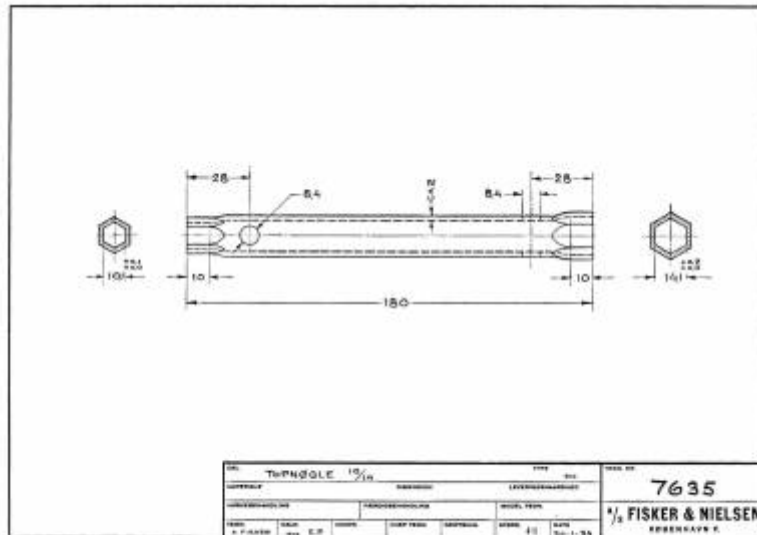

### 7636 Maulschlüssel 17 x 19 SW / Nøgle 17 - 19 mm

Von dem Maulschlüssel liegt mir bisher leider keine Zeichnung vor

### 7637 Maulschlüssel 10 x 14 SW / Nøgle 10 - 14 mm

Von dem Maulschlüssel liegt mir bisher leider keine Zeichnung vor

### 7640 Reifenmontierwerkzeug / Dækjern

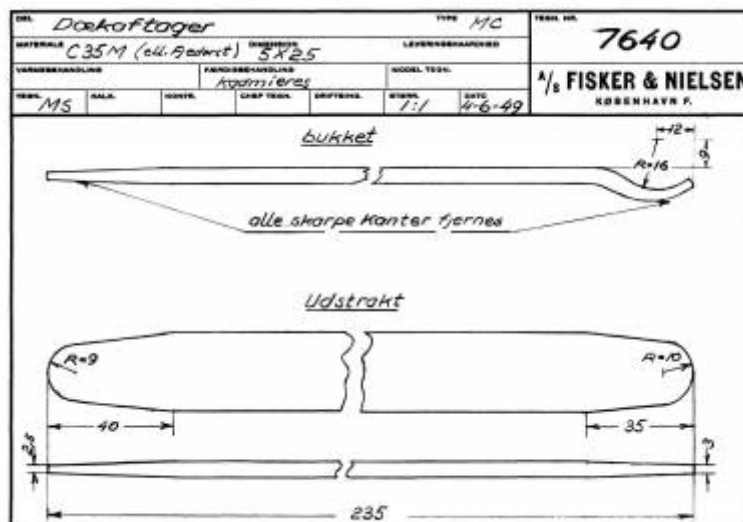

### 7697 Stift für 7634 und 7635 / Pind

|                                     |                      |                  |                        |                    |                           |  |  |
|-------------------------------------|----------------------|------------------|------------------------|--------------------|---------------------------|--|--|
| Del: <i>Tærepind for Topnøgler</i>  |                      | Page: <i>N33</i> |                        |                    |                           |  |  |
| Fabrik: <i>Fisker &amp; Nielsen</i> | Dato: <i>10-4-34</i> | Skæ: <i>1:1</i>  | Titel: <i>Tærepind</i> | Arbejds: <i>60</i> | Legning Nr: <i>7697-A</i> |  |  |
| Materiale: <i>Benard A-10</i>       |                      | Hvæ: <i></i>     |                        | Nr: <i></i>        | Ar: <i></i>               |  |  |
| DIN 6681 E-5,08 5/16                |                      |                  |                        |                    |                           |  |  |

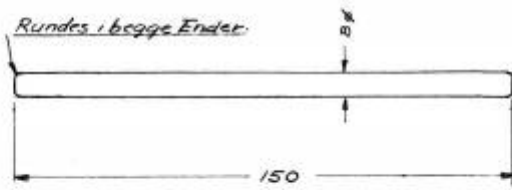

*Matfornikles*

**7807 Maulschlüssel 6 mm mit Ventillehre / Nøgle 6 mm med Søgerblade**

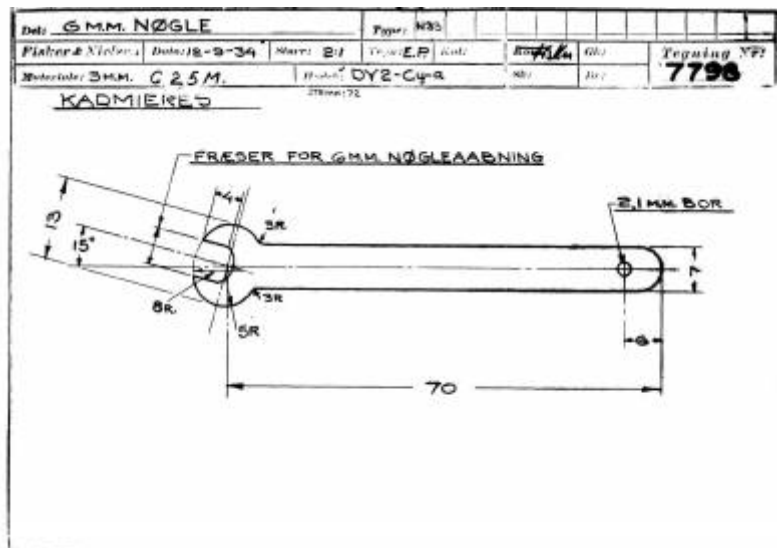
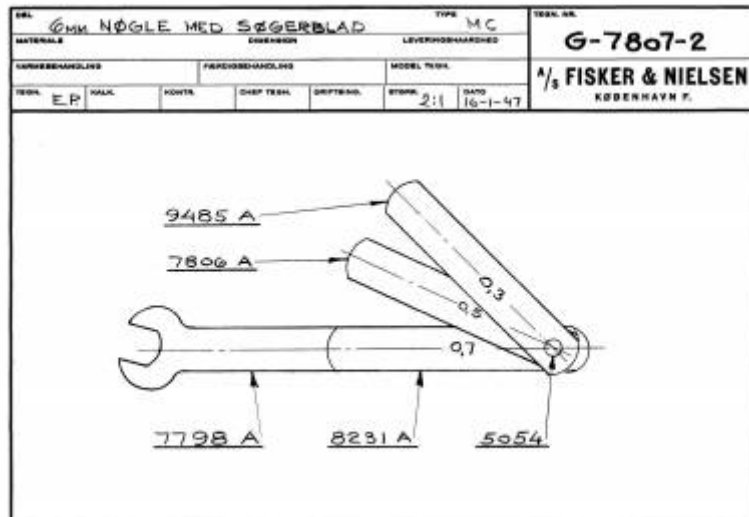

|                            |                |            |            |       |       |      |                           |  |  |
|----------------------------|----------------|------------|------------|-------|-------|------|---------------------------|--|--|
| Titel: 0,7 MM. SØGERBLAD   |                | Type:      |            |       |       |      |                           |  |  |
| Fisker & Nielsen           | Dato: 10-10-85 | Nærri: 2/1 | Tegn: E.P. | Kalz: | Kont: | Gli: | Tegning Nr: <b>8231-A</b> |  |  |
| Materiale: BAANDSTAAL C70. |                | Batch:     |            | St:   |       | Nr:  |                           |  |  |
| 0,7x7                      |                |            |            |       |       |      |                           |  |  |
|                            |                |            |            |       |       |      |                           |  |  |
|                            |                |            |            |       |       |      |                           |  |  |

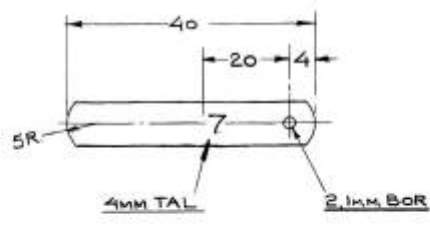

|                            |               |            |            |       |       |      |                           |  |  |
|----------------------------|---------------|------------|------------|-------|-------|------|---------------------------|--|--|
| Titel: 0,5 MM. SØGERBLAD   |               | Type: 1981 |            |       |       |      |                           |  |  |
| Fisker & Nielsen           | Dato: 12-8-84 | Nærri: 2/1 | Tegn: E.P. | Kalz: | Kont: | Gli: | Tegning Nr: <b>7806-A</b> |  |  |
| Materiale: BAANDSTAAL C70. |               | Batch:     |            | St:   |       | Nr:  |                           |  |  |
| 0,5x7                      |               |            |            |       |       |      |                           |  |  |
|                            |               |            |            |       |       |      |                           |  |  |
|                            |               |            |            |       |       |      |                           |  |  |

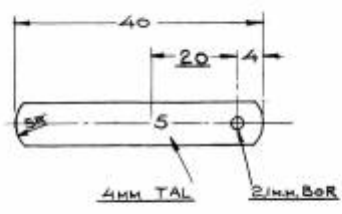

|                          |       |                     |            |                      |        |       |  |  |  |
|--------------------------|-------|---------------------|------------|----------------------|--------|-------|--|--|--|
| Titel: 0,3 MM. SØGERBLAD |       | Type: MC            |            | TEK. NR. <b>9485</b> |        |       |  |  |  |
| MATERIALE: C70.          |       | DIMENSION: 0,3x7 mm |            | LEVERINGSMÅNED: 1984 |        |       |  |  |  |
| KUMMERBILAGS NR.         |       | PERSONBILAGS NR.    |            | MODEL TEGL.          |        |       |  |  |  |
| TEGL.                    | KALK. | KONT.               | CHEF TEGL. | UDFØRER.             | STAMP. | DATO. |  |  |  |
|                          |       |                     |            |                      |        |       |  |  |  |
|                          |       |                     |            |                      |        |       |  |  |  |

Technical drawing of a saw blade. The drawing shows a cylindrical component with a total length of 40 mm. A hole with a diameter of 4 mm is located 20 mm from the right end. The hole is chamfered with a 5R radius. The drawing also indicates a 3 mm TAL (thickness) and a 2 mm BOR (hole diameter).

From:

<https://www.nimbus-motorrad.de/dokuwiki/> - **Nimbus-Motorrad-Wiki**

Permanent link:

<https://www.nimbus-motorrad.de/dokuwiki/doku.php?id=hauptseite:technik:baugruppen:diverses:werkzeug:werkzeugsatz>

Last update: **04.06.2018 23:49**

